



HALE  
SOLID. SINCE 1907.



# ABOUT HALE

At Hale, every piece of furniture that leaves our factory is a reflection of who we are and where we've been.

We're a family.

We're master craftsmen.

We have a reputation as solid as our furniture, which is proudly made, and sourced, in the USA. Our standards were set more than 100 years ago. We set them high, and four generations have kept them there.

Today, we build on our rich history by looking ahead – embracing new markets, new designs and new techniques. And while we let a few machines lend a hand with some of the cuts, we still never cut a single corner.

That's just a part of our story, and we could keep on telling it. But we'd rather let you see it come to life in the furniture we build, with pride, just for you.





## MADE IN THE USA

Hale Manufacturing is proud to support American families by sourcing and building our products here in America.

We produce our beautiful furniture in the historic Mohawk Valley region of New York State.



# ENVIRONMENTAL

The Northeast forest is the largest intact forest ecosystem east of the Mississippi that spans 30 million acres across Maine, New Hampshire, Vermont and New York.

Its ecological significance is well-known with vast areas of wild forest, critical habitat and the headwaters of major rivers.

But it is more than an ecological resource. It is also home to 2 million people whose cultures, livelihoods, families, aspirations and dreams are tied to the forest.

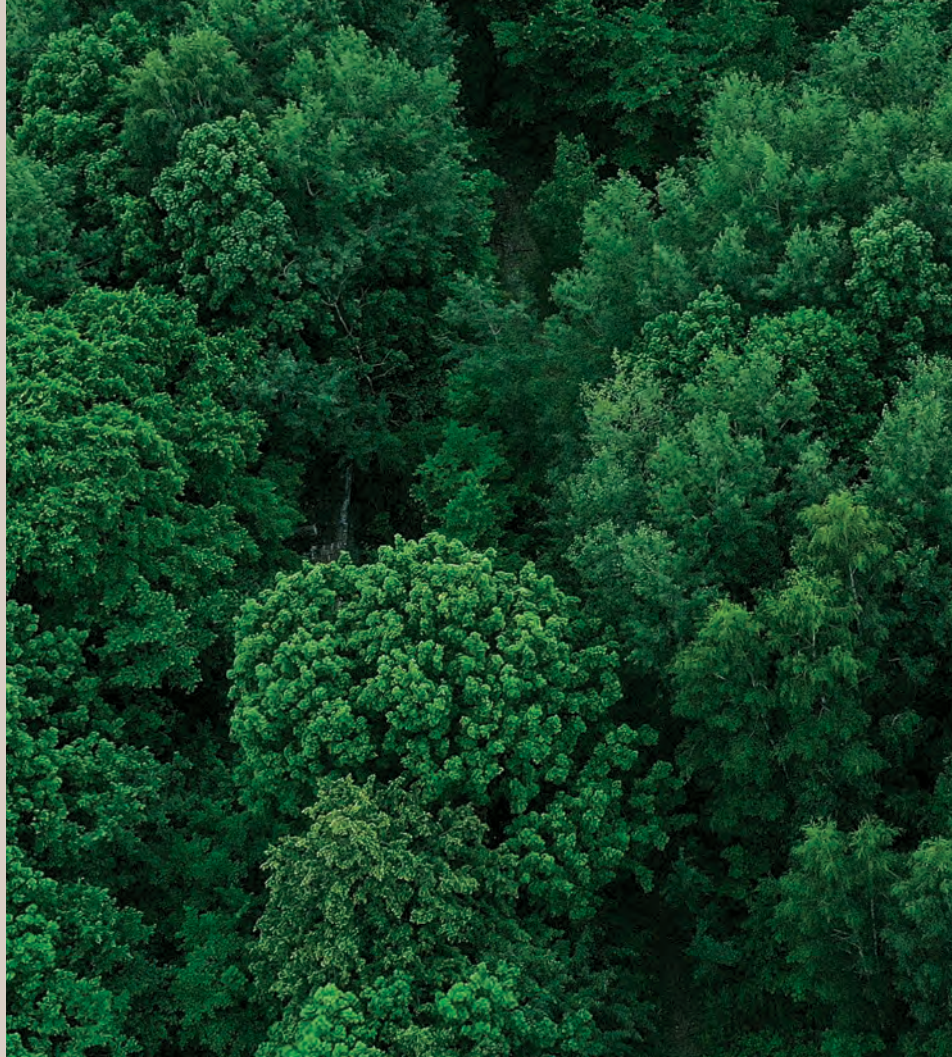





Hale Manufacturing Co. and its employees are proud to call this home.

It is our intent to conduct all aspects of business, from the purchasing department to the finishing and packaging departments, in an environmentally responsible way to protect our planet for future generations.



# CUSTOM IS OUR STANDARD

Hale Manufacturing prides itself on being artisans in quality woodcraft and although we are best known for our bookcases, we can also custom build many variations of furniture for the library, home or office.

Whether filling a single odd size wall space, or setting up a complete library, you provide the requirements...

HALE provides the solution.









HALE  
SOLID. SINCE 1907.







# CHILI PUBLIC LIBRARY

CHILI, NY

- Shelving consisting of metal shelves, wood end panels and wood canopy tops, tiered displays, custom bump out for book sale area, wood benches for children's area.

**TIOGA  
SERIES  
WITH METAL  
SHELVES**

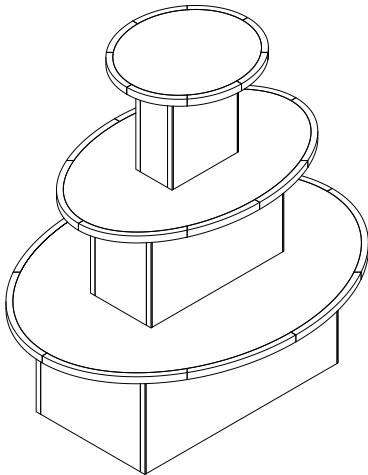











**H**  
**HALE**  
SOLID. SINCE 1907.

# IRONDEQUOIT PUBLIC LIBRARY

IRONDEQUOIT, NY

- Architect asked us to replicate the circle design of the staircase railings onto our end panels.
- Shelving consisting of metal shelves, wood end panels and canopy tops. Wood chairs and tables. CD storage cases. Children's height computer tables.

**TIOGA SERIES  
WITH CUSTOM  
DETAILED  
INLAY AND  
METAL  
SHELVES**

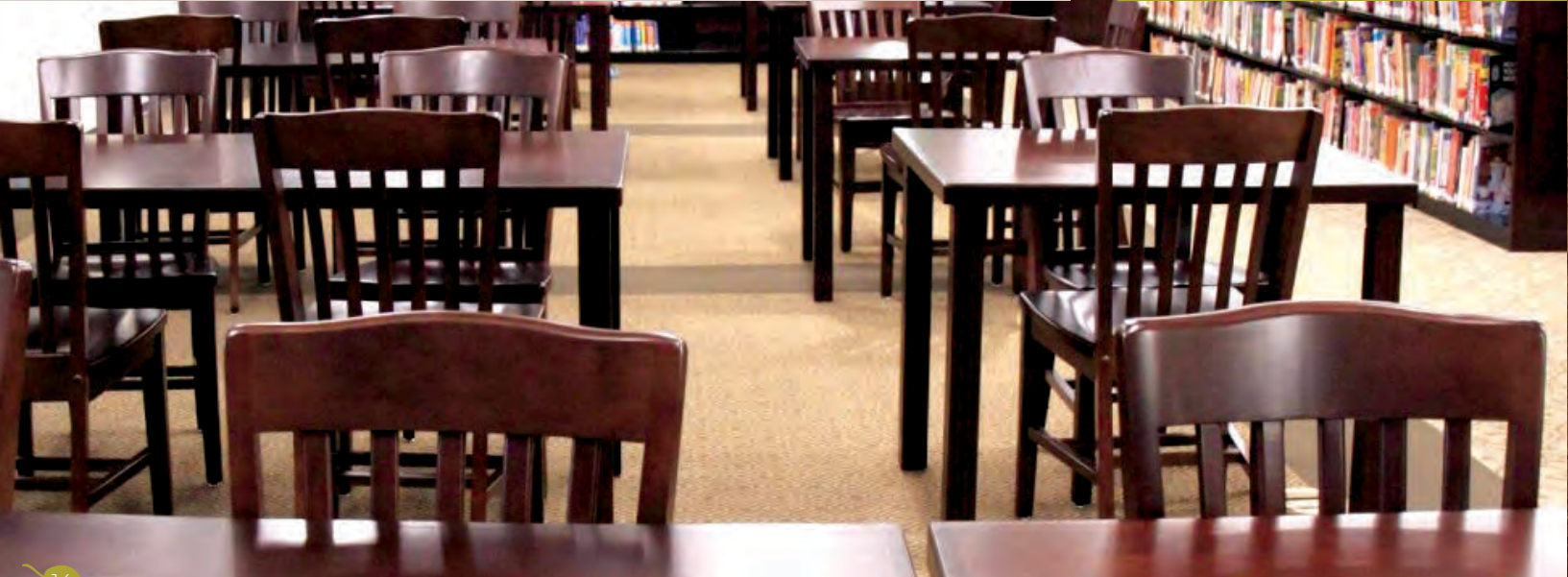











**HALE**  
SOLID. SINCE 1907.

# HENRIETTA PUBLIC LIBRARY

HENRIETTA, NY

- Shelving consisting of metal shelves, wood end panels and canopy tops. Variety of end panel designs consisting of metallic magnetizable inlays, slat wall, iPad storage, end of range display. Book browser bins in the children's room. Three tiered display. Study carrels with acrylic dividers.

**TIOGA  
SERIES  
WITH METAL  
SHELVES**









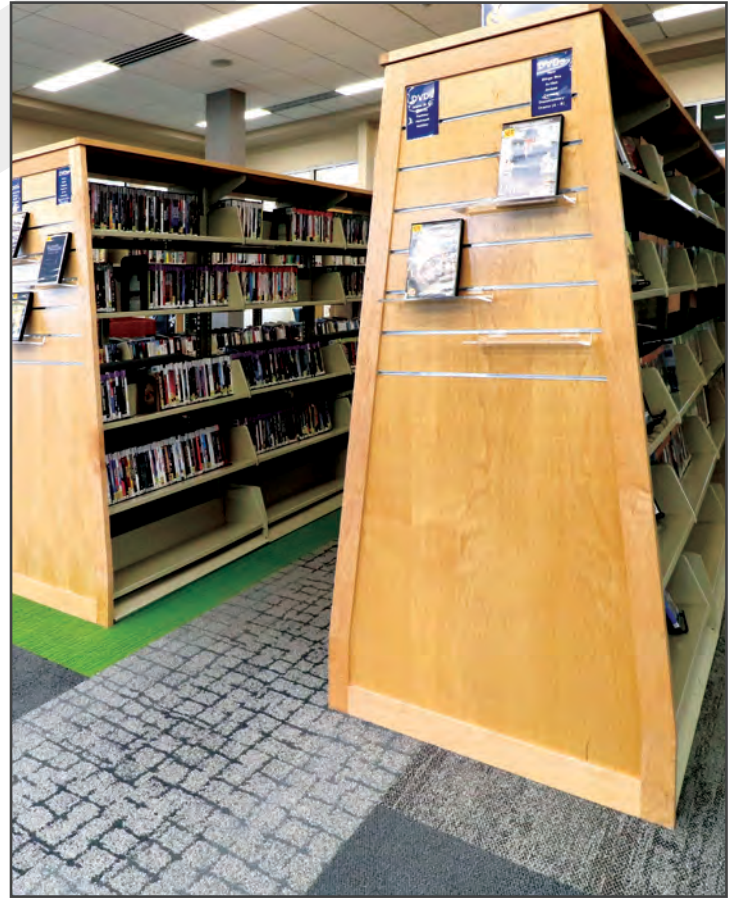





**HALE**  
SOLID. SINCE 1907.

# UTICA PUBLIC LIBRARY

UTICA, NY

- Designed in house by Hale engineering team.
- Reference and circulation desks.
- Mobile Wood shelving in the children's room.

**SHELVING  
IS MOHAWK  
SERIES AND  
DESKS ARE  
CUSTOM**

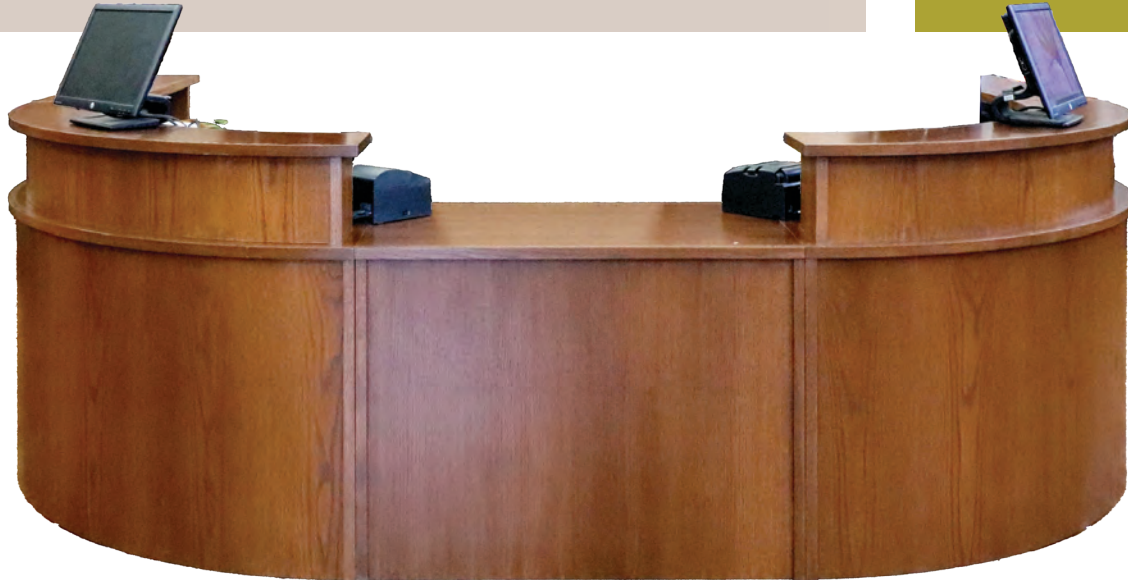











# NEW HARTFORD COURTHOUSE

NEW HARTFORD, NY

- Designed in house by Hale engineering team.
- Spectator benches, judges box with witness stand and stenographer areas included.

**BASIS OF  
DESIGN  
IS TIOGA  
SERIES**





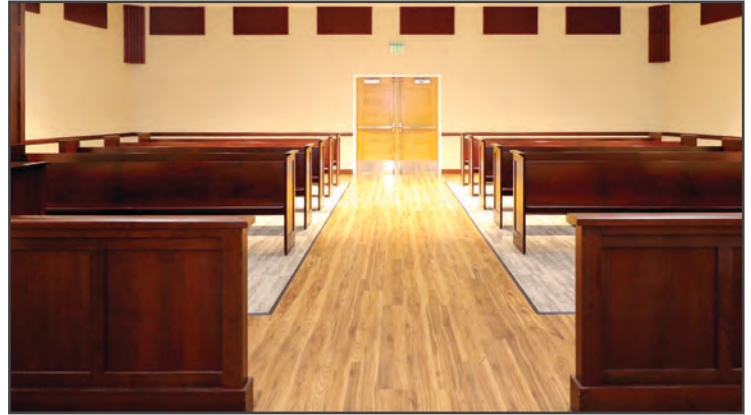
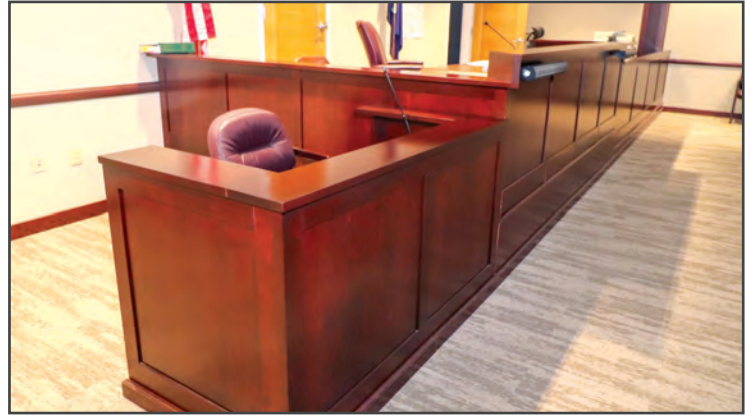

# GUILDERLAND

GUILDERLAND, NY

- Scope included stationary and mobile shelving, magazine storage and custom circulation desks.
- Standard Mohawk Series design with metal shelves.
- Worked with designer to create custom blue end panel signage and circulation desk.

## MOHAWK SERIES









Library catalog interface showing a grid of book covers. The interface includes sections for "Popular Ebooks" and "Popular Audiobooks".

Popular Ebooks

Popular Audiobooks

Featured







# HALE MANUFACTURING

VARIOUS LOCATIONS

## K-12 MEDIA CENTERS













HALE  
SOLID. SINCE 1907.



HALE  
SOLID. SINCE 1907.

11206 Cosby Manor Rd. ■ Utica, NY 13502

800.USE.HALE ■ 315.894.5490

[www.halemfg.com](http://www.halemfg.com)